













24

	 <b>SERVICE</b> → 
	(0) 91 23 95 50  (0) 17 18 11 43 24 
	(0) 91 23 18 51 55 (0) 91 23 18 52 19 (0) 91 23 30 85
	Service + Spare parts e-mail: <a href="mailto:service@tadanofaun.de">service@tadanofaun.de</a> e-mail: <a href="mailto:spareparts@tadanofaun.de">spareparts@tadanofaun.de</a>
	<b>D</b> → <b>00 49</b>
	<b>A</b> <b>B</b> <b>CH</b> <b>DK</b> <b>F</b>
	<b>GB</b> <b>I</b> <b>N</b> <b>NL</b> <b>P</b>
	<b>E</b> 07 49  <b>S</b> 00 949

TADANO FAUN GmbH  
 Postfach 10 02 64  
 D-91205 Lauf/Germany  
 Tel. (0) 91 23 95 50  
 Fax (0) 91 23 30 85  
<http://www.tadanofaun.de>  
 e-mail: [info@tadanofaun.de](mailto:info@tadanofaun.de)

ALL-TERRAIN  
**ATF 50-3**  
 5-Section

ISO 9001

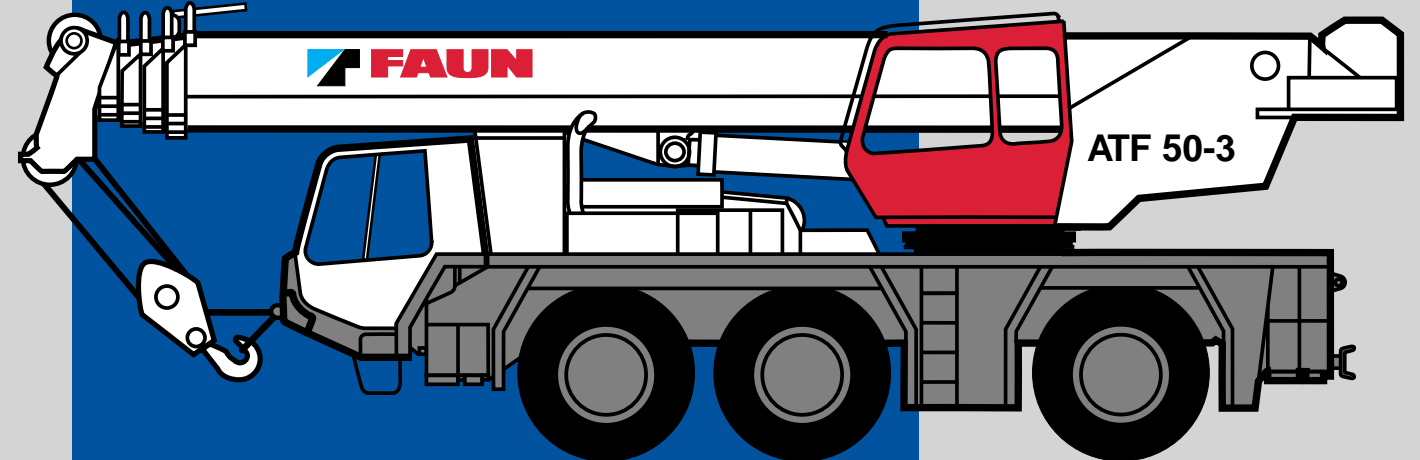

Maße / Dimensions / Dimensions / Dimensiones (mm)  
 Gewichte / Weights / Poids / Pesos  
 Geschwindigkeiten / Speeds / Vitesse / Velocidades

16.00 R 25

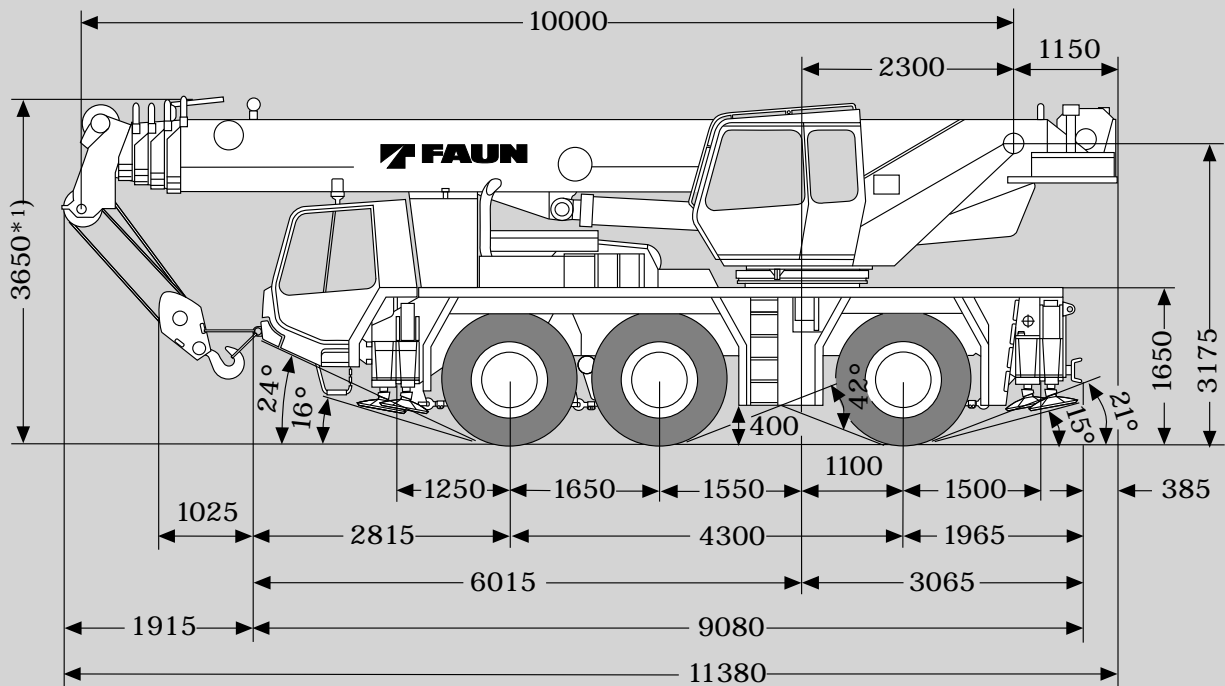

\*) +/- 100 mm  
 1) 14.00 R 25 = 3600

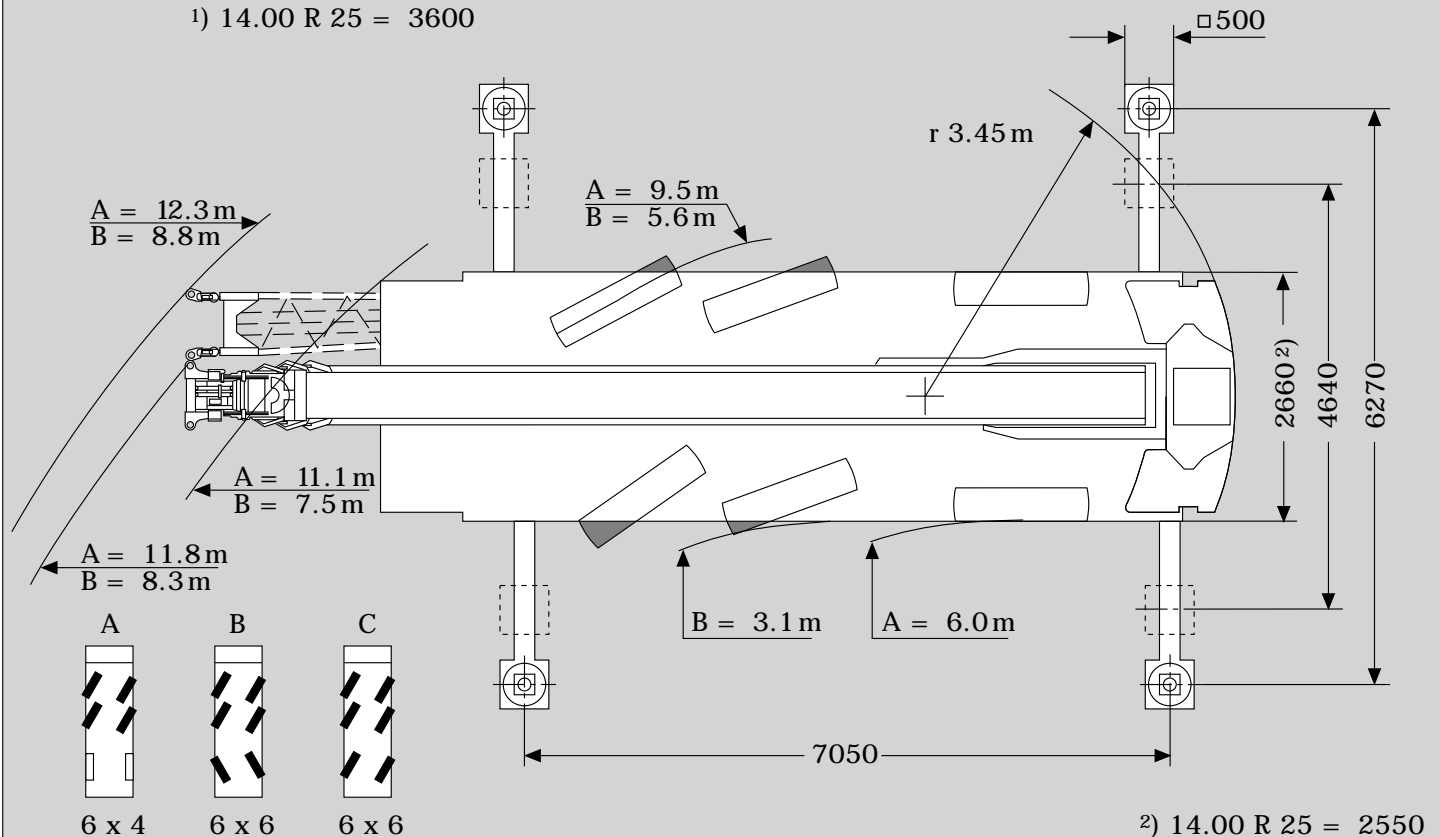

Gewichte / Geschwindigkeiten  
Weights / Working speeds  
Poids / Vitesses  
Pesos / Velocidades de trabajo





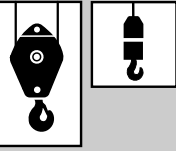

	<b>Achse / Axle Essieu / Eje</b>	1	2	3	<b>Gesamtgewicht / Total weight Poids total / Peso total</b>
	(t)	12	12	12	36*

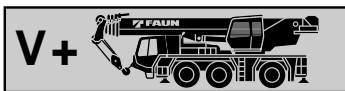



\* Incl. 5,6 t Gegengewicht, Bereifung 16.00 R 25, 32 t Hakenflasche, Antrieb 6 x 6.  
\* Incl. 5.6 t counterweight, tyres 16.00 R 25, 32 t hook block, drive 6 x 6.  
\* Incl. de 5,6 t contrepoids, pneus 16.00 R 25, 32 t moufle, entraînement 6 x 6.  
\* Incl. contrapeso de 5,6 t, neumáticos 16.00 R 25, gancho de 32 t, tracción 6 x 6.

	<b>Traglast / Lifting capacity / Force de levage / Capacidad de elevación</b>	<b>Rollen / Sheaves Pulies / Poleas</b>	<b>Stränge / Parts of line Brins / Ramales de cable</b>	<b>Gewicht / Weight Poid / Peso</b>
	50 t *	5	11	600 kg
	50 t	5	11	600 kg
	32 t *	3	7	300 kg
	32 t	3	7	300 kg
	12.5 t	1	3	170 kg
	6 t	-	1	150 kg

\* Doppelhaken  
\* Rams horn  
\* Moufle avec crochet marin  
\* Gancho doble

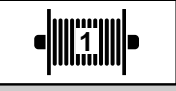

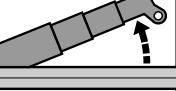
	1	2	3	4	5	6	R		1	2	3	4	5	6	R	
<b>km/h</b> 	9	13	24	34	49	70	9	30%	8	12	22	31	45	64	8	33%
<b>km/h</b> 	0-4	0-6	0-11	0-16	0-23	0-32	0-4	61%	0-4	0-5	0-10	0-14	0-21	0-30	0-4	69%
	16.00 R 25								14.00 R 25							
	Eine maximale Wegstrecke von 70 km pro Stunde darf nicht überschritten werden. A maximum travel distance in one hour must not exceed 70 km. Un parcours de 70 km/heure maximum ne doit pas être dépassé. Una distancia de 70 km/h no puede ser sobrepasado.															

<b>V+</b> 	<b>Stufenlos Infinitely variable Progressivement variable Infinitamente variable</b>	<b>Seil Rope Câble Cable</b>	<b>Max. Seilzug Max. single line pull Effort maxi au brin simple Trio máximo por ramal</b>
	0 - 130 m/min für einfachen Strang single line au brin simple ramal simple	16 mm / 170 m	52 kN
	0 - 70 m/min für einfachen Strang single line au brin simple ramal simple	14 mm / 140 m	39 kN
	0 - 2.5 min <sup>-1</sup>		
	-2° to +82°	ca. 33 s approx. 33 s env. 33 s aproximadamente 33 s	
	10.0 m to 38.6 m	ca. 90 s approx. 90 s env. 90 s aproximadamente 90 s	

Tragfähigkeiten am Teleskopausleger  
Lifting capacities on telescopic boom  
Capacités de levage à la flèche télescopique  
Capacidades de elevación con la pluma telescópica



**DIN**

→ m	10.0 m	17.2 m	17.2 m	17.2 m	24.3 m	24.3 m	24.3 m	31.5 m	31.5 m	35.0 m	38.6 m
2.7	50.0										
3.0	47.1										
3.5	43.8	20.0	30.0	13.0							
4.0	39.5	20.0	29.0	13.0							
4.5	35.5	20.0	27.5	13.0							
5.0	32.5	20.0	26.2	13.0	13.0	17.0	11.8				
6.0	27.0	20.0	22.6	13.0	13.0	17.0	11.8	13.0	9.5		
7.0	21.9	20.0	19.8	13.0	13.0	15.8	11.8	13.0	9.2		
8.0		19.4	17.5	13.0	13.0	14.5	11.8	13.0	8.8	9.0	7.0
9.0		15.7	15.1	13.0	13.0	13.3	11.4	12.0	8.5	8.8	7.0
10.		13.2	12.6	13.0	13.0	12.0	11.0	11.0	8.1	8.5	7.0
0		11.2	10.6	12.5	12.2	10.9	10.5	10.1	7.7	8.3	7.0
11.		9.6	9.1	10.9	10.6	9.4	10.1	9.2	7.4	8.1	7.0
0		7.4	6.9	8.6	8.2	7.1	8.8	7.8	6.7	7.6	6.5
12.					6.4	5.3	7.0	6.0	5.8	6.3	6.1
0					5.1	4.1	5.7	4.8	5.1	5.0	5.3
14.					4.2	3.2	4.8	3.8	4.5	4.1	4.3
0					3.5	2.5	4.0	3.1	4.0	3.3	3.5
16.								2.5	3.6	2.7	2.9
0								1.9	2.8	2.1	2.4
18.								1.5	2.4	1.7	1.9
0										1.3	1.5
20.										1.0	1.2
0											0.9
22.											0.7

I	0	50	100	0	50	100	0	100	0	100	100
II	0	50	0	33	50	100	66	100	100	100	100
III	0	0	0	33	50	0	66	50	100	75	100
IV	0	0	0	33	50	0	66	50	100	75	100



**85%**

→ m	10.0 m	17.2 m	17.2 m	17.2 m	24.3 m	24.3 m	24.3 m	31.5 m	31.5 m	35.0 m	38.6 m
2.7	55.0										
3.0	50.4										
3.5	46.7	22.0	32.0	14.0							
4.0	42.3	22.0	31.2	14.0							
4.5	38.0	22.0	29.6	14.0							
5.0	34.8	22.0	28.2	14.0	14.0	18.5	13.0				
6.0	29.0	22.0	24.4	14.0	14.0	18.5	13.0	14.0	10.5		
7.0	23.6	22.0	21.4	14.0	14.0	17.2	13.0	14.0	10.0		
8.0		21.0	19.0	14.0	14.0	15.8	13.0	14.0	9.6	10.0	7.7
9.0		17.0	16.4	14.0	14.0	14.5	12.4	13.1	9.3	9.7	7.7
10.		14.4	13.7	14.0	14.0	13.1	11.9	12.0	8.9	9.3	7.7
0		12.2	11.6	13.5	13.3	12.0	11.4	11.1	8.4	9.1	7.7
11.		10.5	10.1	11.9	11.6	10.4	11.0	10.1	8.1	8.9	7.7
0		8.2	7.7	9.4	9.0	7.9	9.6	8.6	7.4	8.4	7.2
12.					7.1	6.0	7.7	6.7	6.4	7.0	6.8
0					5.7	4.7	6.3	5.4	5.7	5.6	5.9
14.					4.8	3.7	5.4	4.3	5.0	4.7	4.9
0					4.0	2.9	4.5	3.5	4.5	3.8	4.0
16.								2.9	4.1	3.1	3.3
0								2.2	3.2	2.5	2.8
18.								1.7	2.7	1.9	2.2
0										1.5	1.8
20.										1.2	1.4
0											1.1
22.											0.8

I	0	50	100	0	50	100	0	100	0	100	100
II	0	50	0	33	50	100	66	100	100	100	100
III	0	0	0	33	50	0	66	50	100	75	100
IV	0	0	0	33	50	0	66	50	100	75	100

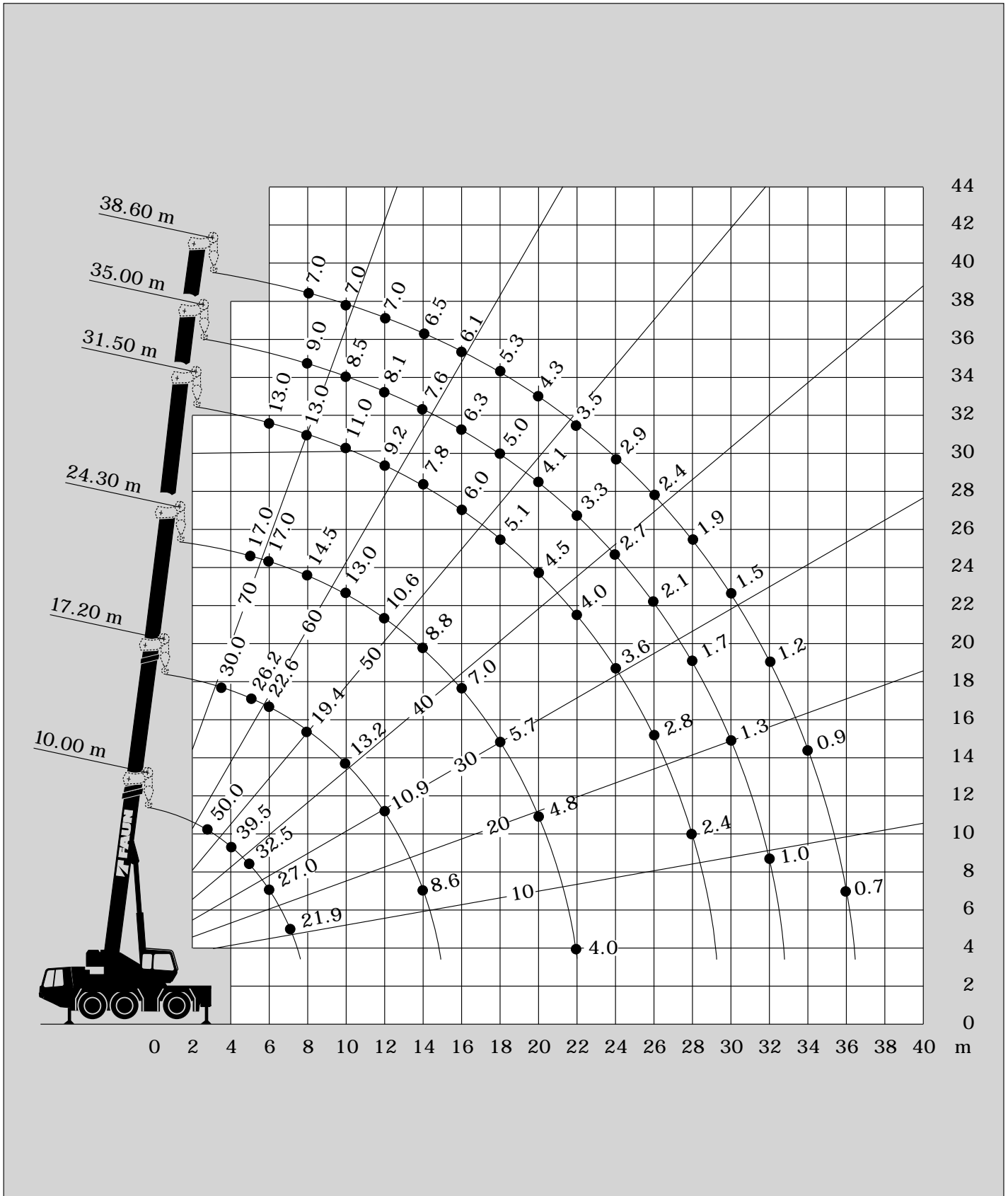

Tragfähigkeiten am Teleskopausleger  
 Lifting capacities on telescopic boom  
 Capacités de levage à la flèche télescopique  
 Capacidades de elevación con la pluma telescópica



→ m	10.0 m	17.2 m	17.2 m	17.2 m	24.3 m	24.3 m	24.3 m	31.5 m	31.5 m	35.0 m	38.6 m
2.7	50.0										
3.0	45.0										
3.5	40.5	20.0	30.0	13.0							
4.0	37.0	20.0	29.0	13.0							
4.5	34.5	20.0	27.5	13.0							
5.0	31.8	20.0	26.2	13.0	13.0	17.0	11.8				
6.0	26.4	20.0	22.6	13.0	13.0	17.0	11.8	13.0	9.5		
7.0	21.0	20.0	19.4	13.0	13.0	15.8	11.8	13.0	9.2		
8.0		15.7	15.0	13.0	13.0	14.5	11.8	13.0	8.8	9.0	7.0
9.0		12.7	12.1	13.0	13.0	12.5	11.4	12.0	8.5	8.8	7.0
10.		10.6	10.0	12.0	11.6	10.3	11.0	11.0	8.1	8.5	7.0
0		8.8	8.2	10.2	9.9	8.6	10.5	9.5	7.7	8.3	7.0
11.		7.4	6.8	8.8	8.4	7.2	9.2	8.0	7.4	8.1	7.0
0		5.4	4.9	6.7	6.3	5.2	7.0	6.0	6.7	6.0	6.5
12.					4.9	3.8	5.5	4.4	5.6	4.6	4.8
0					3.7	2.7	4.3	3.4	4.5	3.6	3.8
14.					2.9	1.9	3.5	2.6	3.6	2.8	3.0
0					2.3	1.3	2.9	2.0	3.0	2.2	2.4
16.								1.4	2.5	1.7	1.9
0								1.0	2.0	1.2	1.4
18.								0.7	1.6	0.8	1.0
0										0.5	0.7
20.											
0											
22.											
0											

I	0	50	100	0	50	100	0	100	0	100	100
II	0	50	0	33	50	100	66	100	100	100	100
III	0	0	0	33	50	0	66	50	100	75	100
IV	0	0	0	33	50	0	66	50	100	75	100



→ m	10.0 m	17.2 m	17.2 m	17.2 m	24.3 m	24.3 m	24.3 m	31.5 m	31.5 m	35.0 m	38.6 m
2.7	55.0										
3.0	48.1										
3.5	43.4	22.0	32.0	14.0							
4.0	39.6	22.0	31.2	14.0							
4.5	37.0	22.0	29.6	14.0							
5.0	34.1	22.0	28.2	14.0	14.0	18.5	13.0				
6.0	28.4	22.0	24.4	14.0	14.0	18.5	13.0	14.0	10.5		
7.0	22.6	22.0	21.0	14.0	14.0	17.2	13.0	14.0	10.0		
8.0		17.0	16.3	14.0	14.0	15.8	13.0	14.0	9.6	10.0	7.7
9.0		13.9	13.3	14.0	14.0	13.7	12.4	13.1	9.3	9.7	7.7
10.		11.6	11.0	13.0	12.6	11.3	11.9	12.0	8.9	9.3	7.7
0		9.7	9.1	11.1	10.8	9.5	11.4	10.4	8.4	9.1	7.7
11.		8.2	7.6	9.6	9.2	8.0	10.0	8.9	8.1	8.9	7.7
0		6.1	5.6	7.4	7.0	5.9	7.7	6.7	7.4	6.7	7.2
12.					5.5	4.4	6.1	5.0	6.2	5.2	5.4
0					4.2	3.1	4.8	3.9	5.0	4.1	4.3
14.					3.3	2.2	4.0	3.0	4.1	3.2	3.5
0					2.6	1.5	3.3	2.3	3.4	2.5	2.8
16.								1.6	2.9	2.0	2.2
0								1.2	2.3	1.4	1.6
18.								0.8	1.9	1.0	1.2
0										0.6	0.8
20.											0.5
0											
22.											
0											

I	0	50	100	0	50	100	0	100	0	100	100
II	0	50	0	33	50	100	66	100	100	100	100
III	0	0	0	33	50	0	66	50	100	75	100
IV	0	0	0	33	50	0	66	50	100	75	100

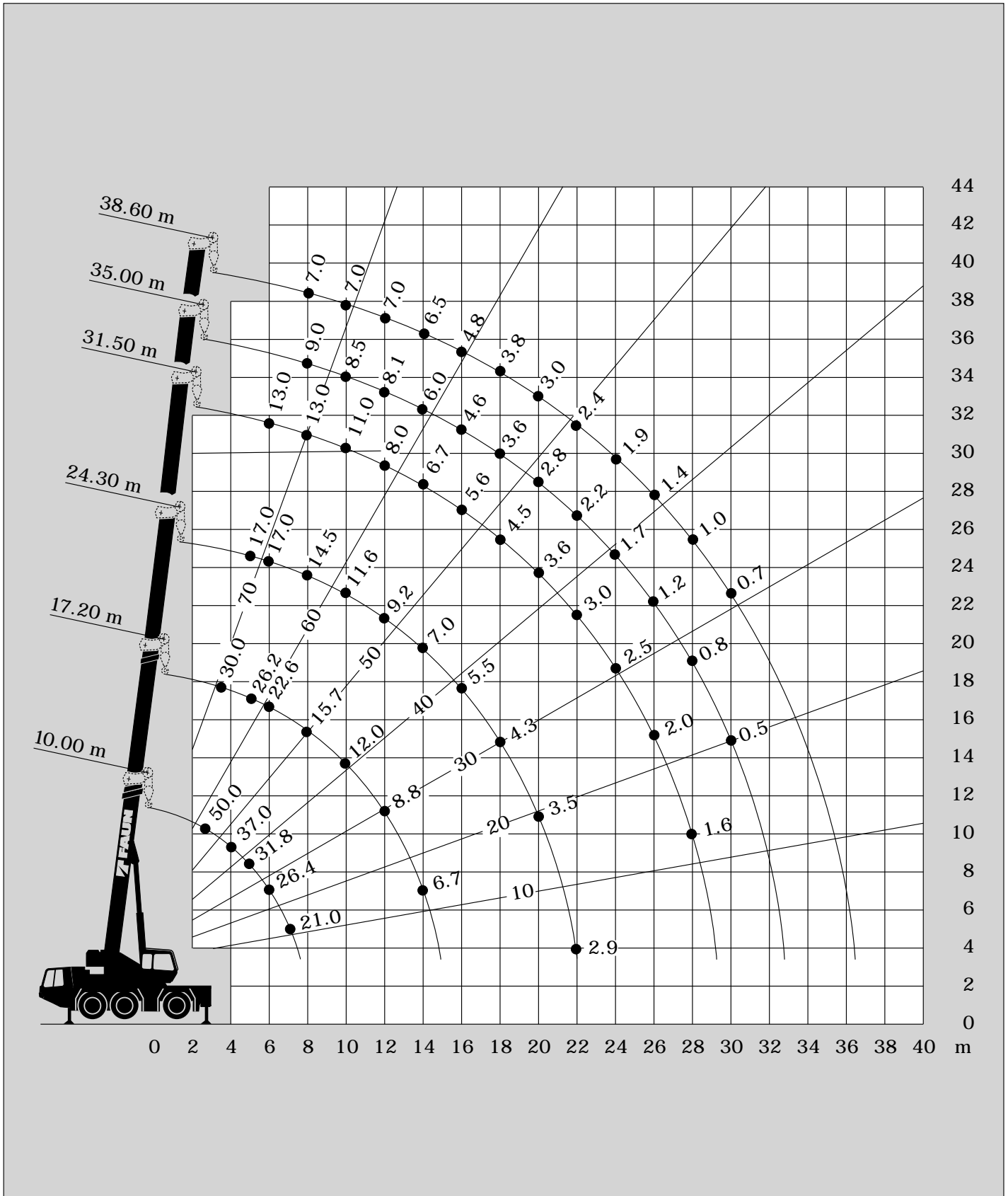

Tragfähigkeiten am Teleskopausleger  
Lifting capacities on telescopic boom  
Capacités de levage à la flèche télescopique  
Capacidades de elevación con la pluma telescópica



→ m	10.0 m	17.2 m
3.0	10.8	11.4
3.5	9.6	10.2
4.0	8.6	9.2
4.5	7.7	8.3
5.0	7.0	7.6
6.0	5.7	6.3
7.0	4.8	5.4
8.0		4.6
9.0		3.9
10.		3.3
0		2.9
11.		2.5
0		1.9
12.		
0		
14.		
0		

%	I	0	0
	II	0	33
	III	0	33
	IV	0	33



→ m	10.0 m	17.2 m
3.0	10.4	11.1
3.5	9.2	9.9
4.0	8.2	8.9
4.5	7.4	8.1
5.0	6.7	7.3
6.0	5.5	6.1
7.0	4.5	5.2
8.0		4.4
9.0		3.8
10.		3.3
0		2.8
11.		2.4
0		1.8
12.		
0		
14.		
0		

%	I	0	0
	II	0	33
	III	0	33
	IV	0	33



→ m	10.0 m	17.2 m
3.0	12.0	12.5
3.5	10.5	11.1
4.0	9.5	10.0
4.5	8.5	9.1
5.0	7.8	8.3
6.0	6.4	7.0
7.0	5.5	6.0
8.0		5.2
9.0		4.4
10.		3.8
0		3.3
11.		2.9
0		2.2
12.		
0		
14.		
0		

%	I	0	0
	II	0	33
	III	0	33
	IV	0	33



→ m	10.0 m	17.2 m
3.0	11.4	12.0
3.5	10.1	10.8
4.0	9.0	9.7
4.5	8.2	8.9
5.0	7.4	8.0
6.0	6.2	6.7
7.0	5.1	5.8
8.0		4.9
9.0		4.3
10.		3.8
0		3.2
11.		2.8
0		2.1
12.		
0		
14.		
0		

%	I	0	0
	II	0	33
	III	0	33
	IV	0	33





DIN

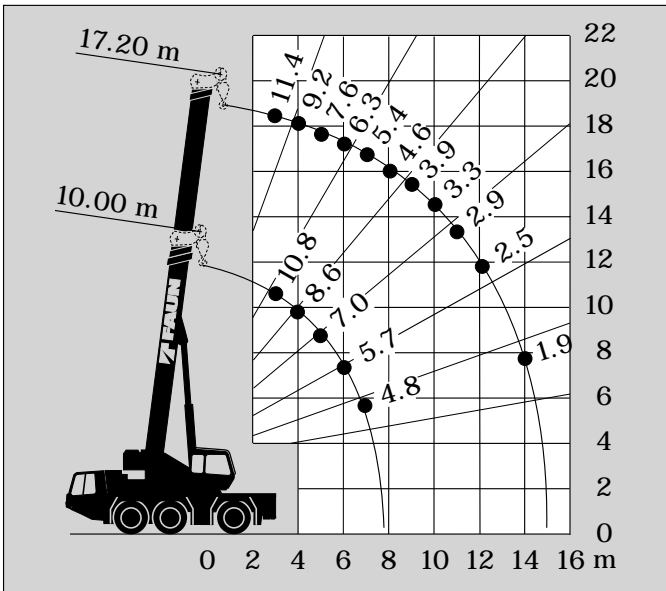

DIN

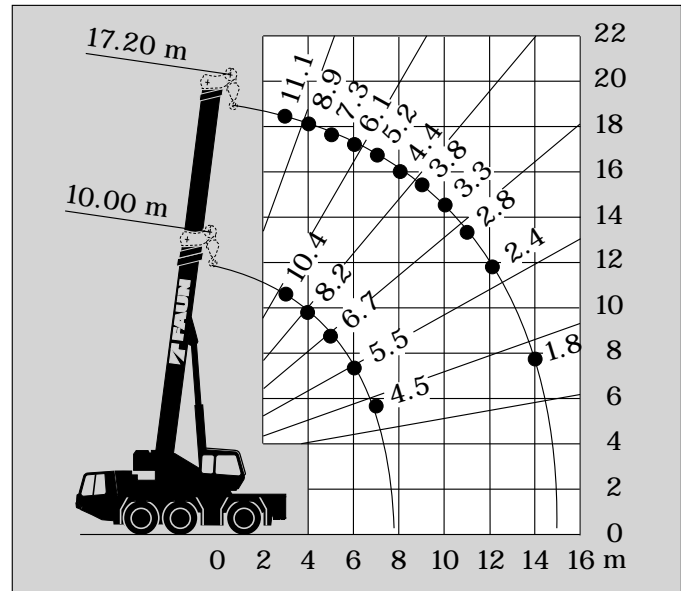

### Anmerkungen zu den Traglasttabellen

Die Tragfähigkeiten im Festigkeitsbereich basieren auf DIN 15018 Blatt 2 und Blatt 3 und F.E.M.

Die Tragfähigkeiten im Standsicherheitsbereich entsprechen DIN 15019 Teil 2.

Die 85% Tragfähigkeitsangaben überschreiten nicht 85% der Kippplast. Dynamische Einflüsse und Wind reduzieren die Tragfähigkeiten. Die 85% Tragfähigkeitsangaben entsprechen nicht den Sicherheitsanforderungen der EG-Maschinen-Richtlinie.

Die zulässige Windgeschwindigkeit beträgt maximal 15 m/sec.

Die Tragfähigkeiten sind in metrischen Tonnen angegeben.

Das Gewicht des Lasthakens bzw. der Hakenflasche und weiterer Anschlagmittel ist von der Tragfähigkeit abzuziehen.

Die Tragfähigkeiten für den Teleskopausleger gelten nur bei demontierter Spitze.

Die Ausladung ist der horizontale Abstand von Mitte Drehkranz bis Mitte freihängender, nicht schwingender Last.

Tragfähigkeitsänderungen vorbehalten.

Obige Angaben dienen nur zur Information. Die Bedienungsanleitungen müssen zu Rate gezogen werden, bevor die Maschine in Betrieb genommen wird. Alle hier gemachten Angaben beziehen sich auf die Standard-Ausführung. Jegliche Ausrüstungsveränderungen können die angegebenen Werte beeinflussen.

### Remarks concerning the load charts

The lifting capacities in the structural area are based on DIN 15018 parts 2 and 3 and F.E.M.

The lifting capacities in the stability area are based on DIN 15019 part 2.

The 85% lifting capacities do not exceed 85% of tipping load. Dynamic influences and wind reduce the lifting capacities.

The 85% lifting capacities do not comply with the safety requirements of the EEC Machinery Directive.

The maximum permissible wind speed for crane operation is 15 m/sec.

The lifting capacities shown are in metric tons.

The weight of load handling devices such as hook blocks, slings, etc., must be considered as part of the load and must be deducted from the lifting capacities.

The lifting capacities for the telescopic boom apply to a crane with no boom extensions being stowed or mounted on the crane.

The working radius is the horizontal distance from the centre of rotation to the centre of the freely suspended non-oscillating load.

The lifting capacities are subject to change without prior notice.

The above remarks are for basic information only and the operator's manual must be consulted before operating this crane. All data and performances refer to the standard crane. The addition of optional and other equipment may affect the performance of the crane.

### Remarques relatives aux tableaux des charges

Les forces de levage sont conformes aux normes DIN 15018, p. 2 et 3, et F.E.M.

Les forces de levage dans la partie de stabilité au renversement sont conformes aux normes DIN 15019, chap. 2.

Les charges de levage indiquées de 85% ne dépassent pas 85% de la charge de renversement. Les influences dynamiques et le vent réduisent les charges de levage. Les charges de levage indiquées de 85% ne correspondent pas aux exigences de sécurité de la directive CE relative aux machines.

La grue peut travailler aux vitesses de vent allant jusqu'à 15 m/s.

Les forces de levage sont données en tonnes métriques.

Le poids du crochet-moufle et de tous les accessoires d'élingage font partie de la charge et sont à déduire des charges indiquées.

Les forces de levage indiquées pour la flèche télescopique s'entendent flèche déposée.

Comme portée, on entend la distance horizontale du centre de la couronne de rotation au centre de la charge librement suspendue et non oscillante.

Sauf modification de forces de levage.

Les données ci-dessus servent à titre d'information. Avant la mise en marche de la grue il est conseillé d'étudier les instructions de service. Toutes les données indiquées ci-dessus se réfèrent à la machine de base. Tout changement de l'équipement de la grue peut influencer ces valeurs.

### Notas relativas a los graficos de carga

En cuanto a los datos referentes a resistencia, las capacidades de carga están basados sobre las normas DIN 15018, pág. 2 y 3, y F.E.M.

En cuanto a los datos referentes a estabilidad anti-vuelco, las capacidades de carga están basados sobre las normas DIN 15019, Cap. 2.

Las indicaciones acerca de la capacidad de carga del 85% no superan el 85% de la carga de vuelco. Influencias dinámicas y del viento reducen las capacidades de carga. Las indicaciones acerca de la capacidad de carga del 85% no corresponden a las normas de seguridad según la directiva para máquinas de la CE.

La velocidad anemométrica max. admisible es de 15 m/seg.

Las capacidades de carga indicadas en las tablas corresponden a toneladas métricas.

Hay que deducir los pesos del gancho o del motón y de otros dispositivos para fijación de cargas de los valores de capacidad de carga indicados en las tablas.

Las capacidades de carga referentes a la pluma telescópica rigen solamente si la punta está desmontada.

Como alcance se entiende la distancia horizontal desde el centro de la corona de rodaduras hasta el centro de la carga suspendida libremente y no oscilante.

Salvo modificación de capacidades de carga.

Los datos arriba indicados sirven solamente para su información. Hay que leer las instrucciones para el uso antes de la puesta en servicio de la máquina. Todos los datos mencionados en las presentes tablas rigen para los modelos standard. Cualquier modificación del equipo montado puede dar lugar a modificaciones de aquellos valores.

Tragfähigkeiten an der Spitze\*  
 Lifting capacities on boom extension\*  
 Capacités de levage à la rallonge de flèche\*  
 Capacidades de elevación con plumin\*

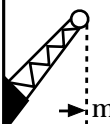

	35.0 m + 9.0 m			38.6 m + 9.0 m			38.6 m + 16.0 m		
	5°	17°	30°	5°	17°	30°	5°	17°	30°
10.	4.80			3.80					
0	4.80			3.80					
11.	4.80	4.00	3.00	3.80	3.40		2.20		
0	4.60	3.75	2.83	3.80	3.40	2.80	2.20	1.80	
12.	4.40	3.45	2.66	3.68	3.26	2.69	2.20	1.80	1.30
0	4.20	3.15	2.51	3.55	3.12	2.57	2.13	1.73	1.30
14.	3.75	2.92	2.37	3.43	2.98	2.46	2.06	1.66	1.27
0	3.39	2.72	2.25	3.30	2.84	2.34	1.99	1.59	1.23
16.	2.70	2.53	2.14	2.80	2.70	2.23	1.92	1.51	1.20
0	2.20	2.35	2.04	2.25	2.40	2.14	1.85	1.44	1.17
18.	1.75	1.85	1.96	1.85	1.95	2.05	1.70	1.37	1.13
0	1.40	1.50	1.60	1.45	1.60	1.70	1.57	1.30	1.10
20.	1.05	1.15	1.20	1.15	1.20	1.30	1.46	1.23	1.05
0	0.75	0.85	0.90	0.85	0.95	1.00	1.30	1.17	1.01
22.	0.50	0.55	0.60	0.60	0.65	0.70	1.05	1.11	0.98
0							0.80	0.95	0.94
24.							0.60	0.70	0.80
0								0.50	0.60
26.									
0									
28.									
0									

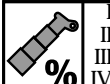
	I	100	100	100
	II	100	100	100
	III	75	100	100
	IV	75	100	100

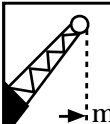

	35.0 m + 9.0 m			38.6 m + 9.0 m			38.6 m + 16.0 m		
	5°	17°	30°	5°	17°	30°	5°	17°	30°
10.	5.50			4.30					
0	5.50			4.30					
11.	5.50	4.50	3.45	4.30	3.90		2.50		
0	5.20	4.30	3.25	4.30	3.90	3.20	2.50	2.05	
12.	5.00	3.96	3.06	4.23	3.75	3.10	2.50	2.05	1.50
0	4.79	3.62	2.89	4.08	3.59	2.96	2.45	2.00	1.50
14.	4.31	3.36	2.73	3.95	3.43	2.83	2.37	1.91	1.46
0	3.89	3.13	2.59	3.80	3.27	2.69	2.29	1.83	1.42
16.	3.10	2.91	2.46	3.20	3.10	2.57	2.21	1.74	1.38
0	2.55	2.70	2.35	2.60	2.75	2.46	2.13	1.66	1.35
18.	2.00	2.15	2.25	2.10	2.25	2.36	1.96	1.58	1.30
0	1.60	1.75	1.85	1.65	1.85	1.95	1.81	1.50	1.27
20.	1.20	1.35	1.40	1.30	1.40	1.50	1.68	1.43	1.21
0	0.85	1.00	1.05	0.95	1.10	1.20	1.50	1.35	1.16
22.	0.60	0.70	0.70	0.70	0.75	0.80	1.20	1.28	1.13
0	0.40	0.40	0.40	0.40	0.50	0.50	0.95	1.10	1.08
24.							0.70	0.80	0.90
0							0.50	0.60	0.70
26.								0.40	0.50
0									
28.									
0									

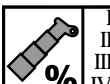
	I	100	100	100
	II	100	100	100
	III	75	100	100
	IV	75	100	100

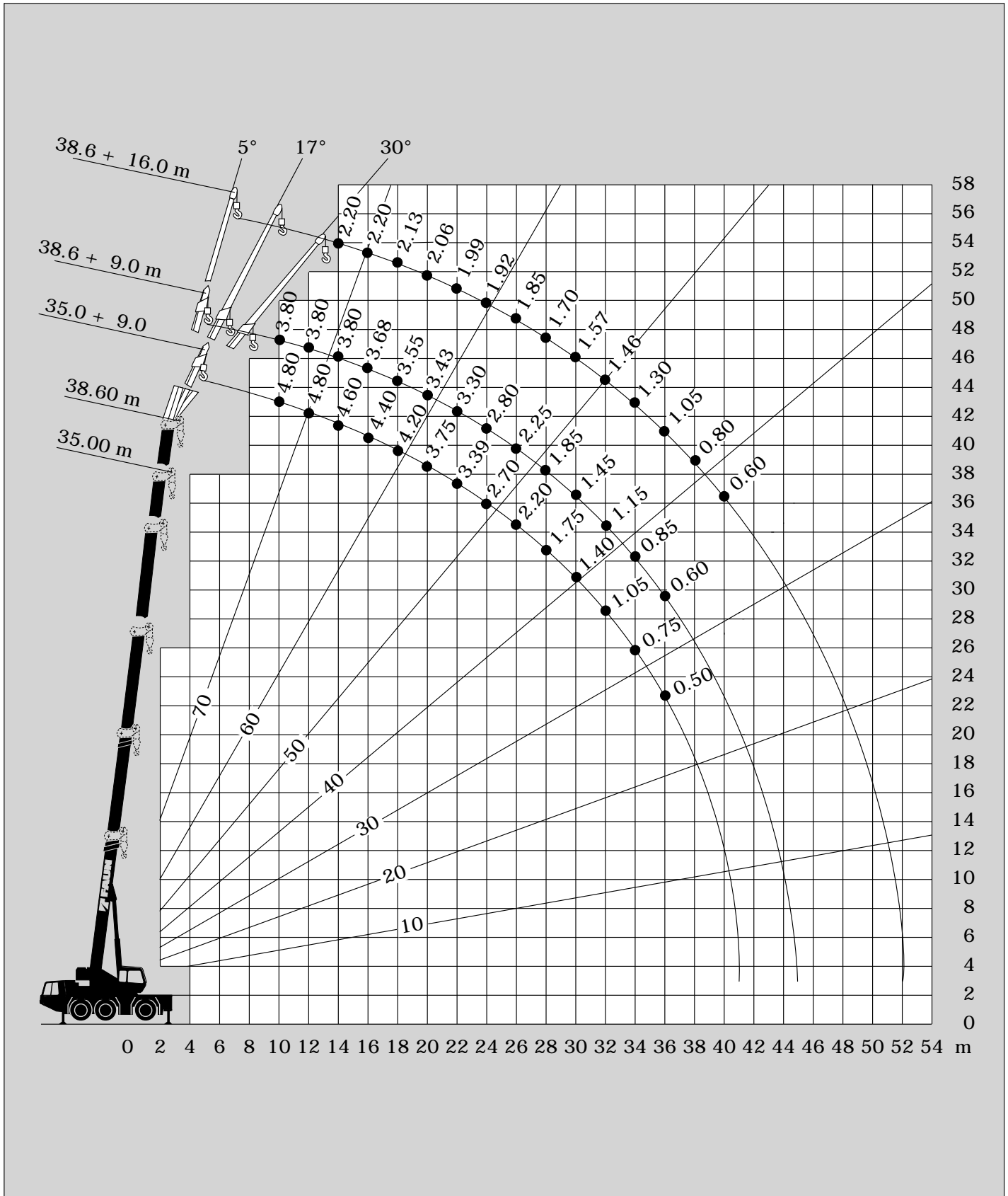

Tragfähigkeiten an der Spitze\*  
 Lifting capacities on boom extension\*  
 Capacités de levage à la rallonge de flèche\*  
 Capacidades de elevación con plumin\*



m	35.0 m + 9.0 m			38.6 m + 9.0 m			38.6 m + 16.0 m		
	5°	17°	30°	5°	17°	30°	5°	17°	30°
10.	4.80			3.80					
0	4.80			3.80					
11.	4.80	4.00	3.00	3.80	3.40		2.20		
0	4.60	3.75	2.83	3.80	3.40	2.80	2.20	1.80	
12.	4.39	3.45	2.66	3.68	3.26	2.69	2.20	1.80	1.30
0	3.75	3.15	2.51	3.55	3.12	2.57	2.13	1.73	1.30
14.	2.90	2.92	2.37	3.00	2.98	2.46	2.06	1.66	1.27
0	2.25	2.45	2.25	2.35	2.34	2.34	1.99	1.59	1.23
16.	1.75	1.90	2.05	1.80	2.00	2.15	1.92	1.51	1.20
0	1.30	1.45	1.60	1.40	1.55	1.70	1.85	1.44	1.17
18.	0.95	1.05	1.20	1.00	1.15	1.25	1.50	1.37	1.13
0	0.60	0.70	0.80	0.65	0.80	0.90	1.15	1.30	1.10
20.			0.50		0.50	0.60	0.85	1.05	1.05
0							0.60	0.80	0.95
22.								0.55	0.70
0									
24.									
0									
26.									
0									
28.									
0									

%	100			100			100		
	I	II	III	I	II	III	I	II	III
II		100			100			100	
III		75			100			100	
IV		75			100			100	



m	35.0 m + 9.0 m			38.6 m + 9.0 m			38.6 m + 16.0 m		
	5°	17°	30°	5°	17°	30°	5°	17°	30°
10.	5.50			4.30					
0	5.50			4.30					
11.	5.50	4.50	3.45	4.30	3.90		2.50		
0	5.20	4.30	3.25	4.30	3.90	3.20	2.50	2.05	
12.	5.00	3.96	3.06	4.23	3.75	3.10	2.50	2.05	1.50
0	4.30	3.62	2.89	4.08	3.59	2.96	2.45	2.00	1.50
14.	3.35	3.36	2.73	3.45	3.43	2.83	2.37	1.91	1.46
0	2.60	2.80	2.59	2.70	2.69	2.69	2.29	1.83	1.42
16.	2.00	2.20	2.35	2.10	2.30	2.50	2.21	1.74	1.38
0	1.50	1.70	1.85	1.60	1.80	1.95	2.13	1.66	1.35
18.	1.10	1.20	1.35	1.20	1.35	1.45	1.75	1.58	1.30
0	0.70	0.80	0.90	0.75	0.90	1.05	1.35	1.50	1.27
20.	0.40	0.50	0.60	0.50	0.60	0.70	1.00	1.20	1.21
0						0.40	0.70	0.90	1.10
22.							0.50	0.65	0.80
0								0.40	0.50
24.									
0									
26.									
0									
28.									
0									

%	100			100			100		
	I	II	III	I	II	III	I	II	III
II		100			100			100	
III		75			100			100	
IV		75			100			100	

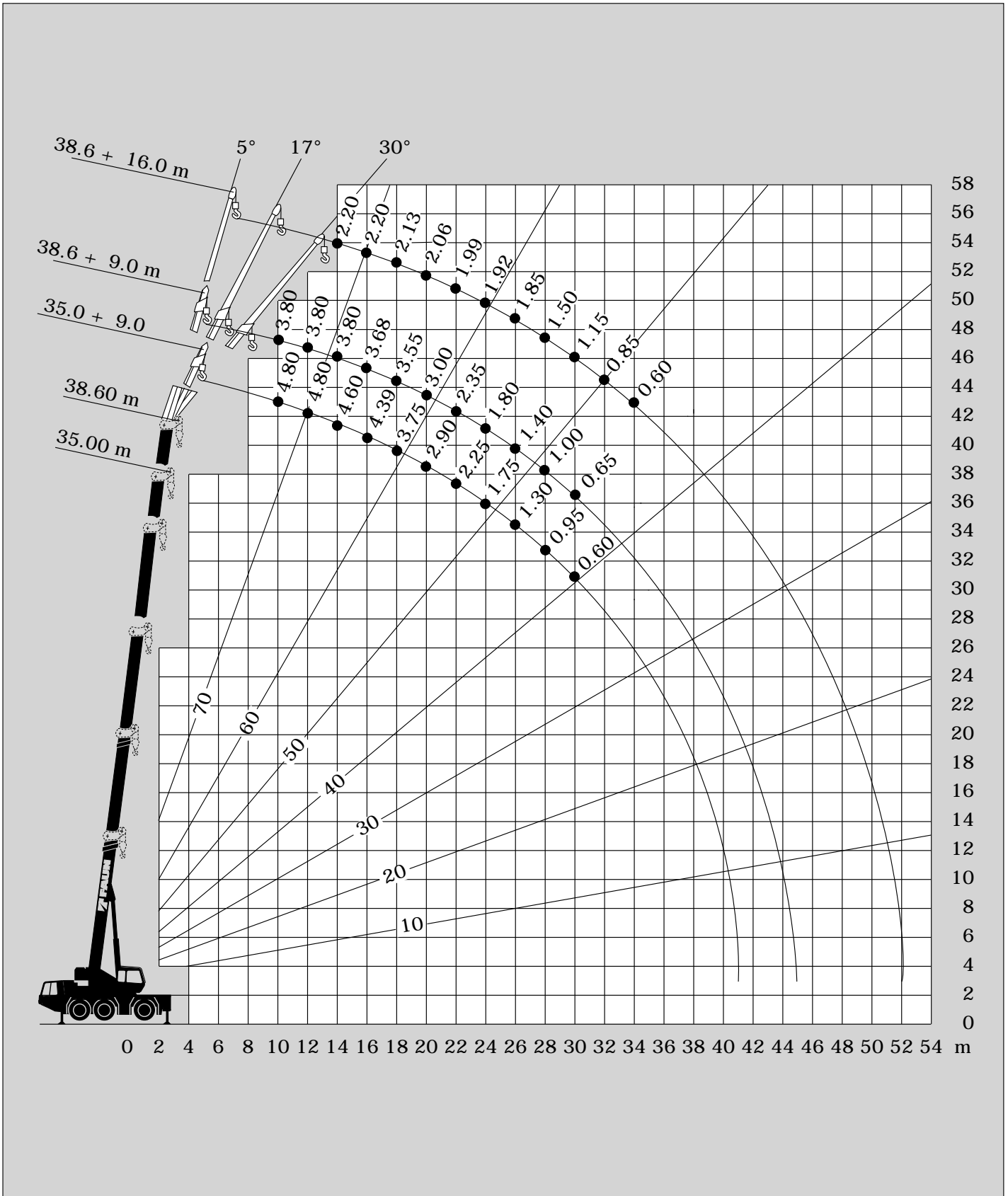

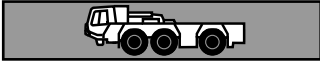
**Rahmen**

Verwindungs- und biegesteife Kastenkonstruktion.

**Abstützungen**

4-Punkt vollhydraulisch. Betätigung vom Oberwagen sowie links und rechts am Fahrgestell.  
Abstützbasis 6.27 m und 4.64 m.

**Motor**

(EURO 1) 6 Zylinder Mercedes Benz wassergekühlt  
OM 441 LA, 250 kW (340) PS bei 2100 U/min.  
Drehmoment: 1450 Nm (148 kpm) bei 1200 U/min.

**Getriebe**

ZF-Lastschaltgetriebe mit Drehmomentwandler und Lock-up-Kupplung (ab 1. Gang) mit 6 Vorwärts- und 1 Rückwärtsgang.

**Achsen**

3 lenkbare Planetenachsen mit Differentialsperre.

**Antrieb**

6x6/6x4 für Gelände  
6x2 für Straße

**Federung**

Hydro-pneumatisch, hydraulisch blockierbar mit Niveauregulierung.

**Bremsen**

Betriebsbremse: Zweikreis-Druckluft-Bremsanlage.  
Feststellbremse: Federspeicher an der 2. und 3. Achse.  
Dauerbremse: Konstantdrossel-Anlage und Auspuffklappenbremse.

**Bereifung**

6fach 16.00 R25

**Lenkung**

Aus der Fahrgestellkabine: 2-Kreis-Hydro-Halblocklenkung. Mechanische Lenkung der Vorderachsen, hydraulisch unterstützt, mit Notlenkpumpe. Hydrostatische Lenkung aller Achsen aus der Krankabine.

**Fahrerhaus**

Zweimann Fahrerhaus in Stahl-GFK-Verbundkonstruktion, Sicherheitsverglasung, gefederter und hydraulisch gedämpfter Fahrersitz und motorabhängige Warmwasserheizung. Kontroll- und Bedienungselemente für den Fahrbetrieb.

**Elektrische Anlage**

24 Volt Gleichstrom, 2 Batterien.  
Nach der EG-Regulation.

**Rahmen**

Verwindungssteife Schweißkonstruktion. Einreihige Kugeldrehverbindung außenverzahnt zwischen Fahrgestell und Oberwagen um 360° unbegrenzt drehbar.

**Hydrauliksystem**

Dreikreis-Hydraulik-Anlage. 1 Axialkolben-Verstell-Doppelpumpe und 1 dreifach Zahnradpumpe angetrieben vom Fahrmotor. Motorleistung im Kranbetrieb 240 kW (326 PS) bei 1800 U/min. (DIN 6270 B).

**Steuerung**

2 selbstzentrierende Steuerhebel, hydraulische Vorsteuerung.

**Wippwerk**

1 Differentialzylinder mit angebautem Senkbremsventil.

**Drehwerk**

Konstant-Motor, zweistufiges Planetengetriebe mit fußbetätigter Betriebsbremse und mit Feststellung. Drehgeschwindigkeit stufenlos von 0-2.5 U/min.

**Hubwerk**

Axialkolben-Konstantmotor, Hubwerkstrommel mit eingebautem Planetengetriebe und federbelasteter Haltebremse mit integriertem Freilauf.

**Teleskopausleger**

1 Grundkörper, 4 Teleskopteile. Hydraulisch unter Teillast teleskopierbar. 10.0-38.6 m lang.

**Auslegerverlängerung\***

Teleskop-Spitzenausleger seitlich klappbar, 9.0 / 16.0 m lang, unter 5°/17°/30° montierbar.

**Gegengewicht**

5.6 t, teilbar, Betätigung erfolgt aus der Krankabine, 10.2 t\*, teilbar.

**Kranfahrerkabine**

Seitlich links am Oberwagen. Ganzstahlausführung mit Sicherheitsverglasung, gefederter und hydraulisch gedämpfter, verstellbarer Sitz und motorunabhängige Warmluftheizung. Kontroll- und Bedienungselemente für den Kran- und Fahrbetrieb.

**Sicherheitseinrichtungen**

Sicherheitsventile gegen Rohr- und Schlauchbruch, Windenendschalter, Windendrehmelder, Lastmomentbegrenzung und Hubendschalter.



**Frame**  
Torsion and bend resistant box type steel construction.

**Outriggers**  
4 point hydraulic outriggers controlled from upper cab and from both sides of carrier.  
Outrigger spread 6.27 m and 4.64 m.

**Engine**  
(EURO 1) 6 cylinder Mercedes Benz water-cooled engine OM 441 LA, 250 kW (340 HP) at 2100 rpm.  
Torque: 1450 Nm (148 kpm) at 1200 rpm.

**Transmission**  
ZF-Powershift transmission with torque converter with lock-up from 1st gear. 6 forward gears and 1 reverse gear.

**Axles**  
3 steering planetary axles with differential locks.

**Drive**  
6x6/6x4 – off road  
6x2 – on road

**Suspension**  
Hydro-pneumatic, hydraulically lockable with levelling adjustment.

**Brakes**  
Service brake: Dual circuit air brakes.  
Parking brake: Spring loaded acting on 2nd and 3rd axles.  
Engine brake: Constant throttle system and engine exhaust brake.

**Wheels**  
6 x 16.00 R25

**Steering**  
From carrier cab: Dual circuit semi-block. Front two axles mechanically steered with hydraulic assistance and with emergency pump.  
From crane cab: all axles hydro-statically steered.

**Carrier Cab**  
Panoramic design. Two man composite construction cab with safety glass and hydraulically cushioned adjustable seat. Controls and instrumentation for driving. Heater (engine dependent).

**Electrical System**  
24 volt DC system with 2 batteries. According to EEC regulations.



**Frame**  
All welded torsion resistant steel structure with single row ball-bearing slewing ring with external gears for 360° continuous rotation.

**Hydraulic System**  
Engine driven 3 circuit hydraulic system with one variable displacement axial piston double pump and one triple gear pump. Engine rating for crane work 240 kW (326 HP) at 1800 rpm. (DIN 6270 B).

**Controls**  
2 joy-stick type control levers for simultaneous crane motions, hydraulically controlled.

**Boom Hoist**  
One double acting hydraulic cylinder with integral safety check valve.

**Slewing Gear**  
Constant motor with planetary reduction with foot controlled service brake, automatic holding brake and with parking brake.  
Slewing speed 0-2.5 U/min.

**Main Winch**  
Axial piston fixed displacement motor with planetary reduction and spring loaded multiple disc holding brake.

**Telescopic boom**  
1 boom base and 4 telescoping sections. All sections hydraulically extendable under partial load.  
10.0 m - 38.6 m long.

**Boom Extension\***  
2-stage telescopic extension 9.0 m / 16.0 m. Offsets 5° / 17° / 30°.

**Counterweight**  
5.6 t (10.2 t\*) divisible, assembly / disassembly from superstructure cab.

**Crane Cab**  
Left hand mounted Panoramic design. Spacious all-steel structure with special safety glass, hydraulically cushioned adjustable seat and independent hot-air heater. Controls and instrumentation for crane operation and travelling.

**Safety Devices**  
Safety valves against hose and pipe rupture, main winch limit switch and main winch drum turn indicator. Electronic load moment device and anti-two block device.

**Châssis**

Construction mécano-soudée, en forme de caisson, résistante aux flexions et aux torsions.

**Calage**

4 poutres extensibles hydrauliquement à partir de la cabine du grutier et latéralement à gauche et à droite du châssis. Largeur de calage 6.27 m et 4.64 m.

**Moteur**

(EURO 1) Mercedes-Benz diesel OM 441 LA, 250 kW (340 CV à 2100 tr/min) refroidi par eau.

Couple-moteur: 1450 (148 kpm) Nm à 1200 tr/min.

**Boîte de vitesses**

Boîte powershift ZF avec convertisseur de couple et embrayage lock-up (à partir de 1ère vitesse) avec 6 vitesses AV et 1 AR.

**Essieux**

Les 3 essieux planétaires avec blocage différentiel et directeur.

**Entraînement**

6x6/6x4 en tout-terrain

6x2 sur la route.

**Suspension**

Hydro-pneumatique, réglage d'inclinaison à suspension bloquée.

**Freins**

Frein de service: système de frein à air comprimé à double circuit.

Frein de parcage: Frein à accumulateur à ressorts sur 2ème et 3ème essieu.

Frein permanent: Ralentisseur et clapet d'échappement à commande pneumatique.

**Pneumatiques**

6 pneus de 16.00R25

**Direction**

Direction hydraulique semi-bloc à 2 circuits depuis la cabine du conducteur. Direction mécanique des essieux avant, avec pompe hydr. de secours. Direction hydrostatique des 3 essieux à partir de la cabine tourelle.

**Cabine de Conducteur**

Cabine bi-place, construction en matière combinée, avec vitrage en verre de sécurité, siège du conducteur à ressort et amorti hydrauliquement. Chauffage à eau chaude dépendant du moteur. Tableau de bord avec instruments de contrôle et conduite.

**Système électrique**

24 V courant continu, 2 batteries, conforme aux normes CEE.

**Plate forme**

Construction mécano-soudée, résistant à la torsion. Couronne d'orientation avec denture extérieure, permettant une rotation illimitée à 360°.

**Système hydraulique**

Diesel-hydraulique, installation hydraulique à 3 circuits, 1 pompe double à piston type axiale (réglage hydraulique) 1 pompe triple à engrenages entraînée par le moteur porteur. Puissance du moteur pendant le travail de levage 240 kW (326 CV) à 1800 tr/min. (DIN 6270 B).

**Commandes**

2 leviers à commande manuelle universelle et à autocentrage, assistés hydrauliquement.

**Mécanisme de relevage**

Vérin différentiel muni de clapet de sécurité.

**Mécanisme de rotation**

Moteur à débit continu avec entraînement planétaire biétagé. Frein de service actionné par l'intermédiaire d'une pédale et avec arrêt. Vitesse de rotation 0 à 2.5 tr/min.

**Mécanisme de levage**

Moteur hydraulique, tambour de levage avec boîte planétaire incorporée, frein d'arrêt à disques multiples à ressort, libéré lors du levage.

**Flèche télescopique**

1 élément de base et 4 éléments télescopiques, télescopables en charge. Longueur 10.0 m à 38.6 m.

**Rallonge de flèche\***

Construction en treillis avec rallonge mécanique de 9.0 m à 16.0 m, rabattable latéralement et inclinable à 5°/17°/30°.

**Contrepoids**

5.6 t, divisible, commandé à partir de la cabine du grutier (10.2 t\* divisible).

**Cabine de conduite**

Montée du côté gauche. En acier avec vitrage de sécurité, siège suspendu sur ressorts, amorti hydrauliquement et réglable. Chauffage à air chaud indépendant du moteur. Tableau de bord avec instruments de contrôle et de conduite.

**Dispositifs de sécurité**

Clapets anti-retour contre l'éventuelle rupture des conduites ou flexibles, interrupteur de fin de course du treuil pour câble de levage sur le tambour, indicateur du nombre de tours sur tambour de treuil, limiteur de couple de charge, interrupteur de fin de course de levage.

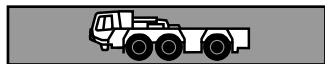

**Chasis**

Construcción de tipo de caja, de acero, resistente a la torsión y a la flexión.

**Estabilizadores**

Estabilizadores hidráulicos controlados desde la cabina superior y desde ambos lados del chasis portante.  
Extensión de los estabilizadores: 6.27 m y 4.64 m.

**Motor**

Mercedes Benz OM 441. 6 cilindros, refrigerado por agua, 250 kW (340 HP) a 2100 rpm.  
Par motor: 1450 Nm (148 kpm) a 1200 rpm.

**Transmisión**

Transmisión powershift ZF por convertidor de par con bloqueo desde la 1ª velocidad. 6 velocidades de avance y 1 de marcha atrás.

**Ejes**

3 ejes planetarios de dirección, con bloqueos diferenciales.

**Tracción**

6 x 6 / 6 x 4 - fuera de carretera  
6 x 2 - en carretera

**Suspensión**

Hidroneumático, con bloqueo hidráulico y ajuste de nivelación.

**Frenos**

Freno de servicio: Frenos de aire con circuito doble.  
Freno de estacionamiento: Cargado por resortes, actuando en los ejes 2º y 3º. Freno del motor: Sistema de estrangulación constante y freno en escape motor.

Neumáticos 6 x 16.00 R 25.

**Dirección**

Desde la cabina del chasis portante: Semibloqueo de doble circuito. Dos ejes delanteros de dirección mecánica, con asistencia hidráulica y con bomba de emergencia. Desde la cabina de la grúa: Todos los ejes dirigidos hidrostáticamente.

**Cabina del chasis portante**

Con diseño panorámico. Cabina de construcción compuesta para dos hombres, lunas de seguridad y sillón regulable amortiguado hidráulicamente. Controles e instrumentos para la conducción. Calefacción (dependiente del motor).

**Sistema eléctrico**

Sistema a 24 V c.c. con 2 baterías. De acuerdo con las normas CEE.

**Superestructura**

Estructura de acero toda soldada, resistente a la torsión, corona de giro de una fila de bolas, con dientes externos para rotación continua de 360°.

**Sistema hidráulico**

De tres circuitos. Bomba doble de pistones axiales de caudal variable y bomba de engranajes triple, accionadas por el motor.

Motor nominal para el trabajo de grúa 240 kW (326 HP) a 1800 rpm. (DIN 6270 B).

**Controles**

2 palancas de control infinito de tipo universal (joystick) para movimientos simultáneos de la grúa, controladas hidráulicamente.

**Elevación de la pluma**

Cilindro hidráulico de doble efecto con válvula de retención de seguridad integrada.

**Sistema de giro**

Motor de toma constante con reducción planetaria, freno de servicio que se controla con el pie, freno de retención automático y freno de estacionamiento.  
Velocidad de giro: 0 - 2.5 rpm.

**Cabrestante**

Motor de pistones axiales de desplazamiento fijo con reducción planetaria y freno de retención multidisco cargado por resortes.

**Pluma telescópica**

Una base de pluma y cuatro tramos telescópicos. Todos los tramos se extienden hidráulicamente bajo carga, longitud de 10.0m a 38.6m.

**Prolongación de la pluma\***

Prolongación telescópica de 2 etapas 9.0 / 16.0 m.  
Con angulación de 5° / 17° / 30°.

**Cabina de la grúa**

De diseño panorámico, montada en el lado izquierdo. Espaciosa, con estructura totalmente de acero y lunas especiales de seguridad, sillón regulable amortiguado hidráulicamente y calefacción por aire caliente independiente. Controles e instrumentos para operación de la grúa y desplazamiento.

**Dispositivos de seguridad**

Válvulas de seguridad contra rotura de tuberías y latiguillos. Interruptor de límite de carrera en cabrestante principal e indicador de vueltas del tambor del cabrestante principal. Dispositivo electrónico de momento de carga y dispositivo interruptor de final de carrera en cabrestante.